

BLACK BT

FULL COLOR OLED

User's manual

Firmware version 2.2

1. xDEEP BLACK BT

xDEEP BLACK BT is a diving instrument measuring time and depth (Bottom Timer), in which we have incorporated the cutting edge technology and high quality components of the world leading manufacturers.

While creating BLACK BT, we did our best to satisfy your expectations and make your dives safer and more pleasant. If you have any remarks to BLACK BT, do not hesitate to contact us. We will be happy to know your opinion.

You can update xDEEP BLACK BT to both nitrox (BLACK EANx) and trimix (BLACK TMX) computers. For more information please visit this website: <http://support.xdeep.eu>.



As we're constantly developing BLACK BT software and some functions may change or extend, if you come across any discrepancies download the latest version from the above mentioned website.

Attention: If a font of this printed manual is too small, you can download it in .pdf version from:
www.xdeep.pl/download

2. CONFORMITY WITH THE EU STANDARDS

BLACK BT was subject to certification issued by notified body and satisfies the requirements of EN 13319:2002 standard „Diving accessories – Depth gauges and combined depth and time measuring devices – Functional and safety requirements, test methods”, which was confirmed by the certificate of conformity CW/GPS/01/2013. The CE marking visible on the instrument indicates conformity with directive 2001/95/EC.

BLACK BT was produced by:

XDEEP spółka z ograniczoną odpowiedzialnością sp. k.

ul. Ogrodników 3, 43-227 Góra, Poland



Attention: BLACK BT consists of built-in lithium-ion battery; therefore it should be properly disposed of after withdrawal from use. In order to receive more information on the disposal of devices containing batteries, contact the vendor or the local authorities.

3. ATTENTION

In this manual some information was marked in a special way by presenting it in a frame with an international symbol. Pay special attention to it.



This symbol is used to indicate significant practical information related to the use of the BLACK TMX.



This symbol was used to indicate information and principles crucial for safety, which, if unknown or not obeyed, may lead to damage of the device or pose high risk of injuries or death resulting from incorrect operation of the device.

4. READ BEFORE USE 1/3

This manual contains a lot of information very important for your safety. Therefore, you must read it carefully and understand it before you start diving with the BLACK BT. Make sure you understand correctly all information. Otherwise, there is a very significant risk of serious injury or even death resulting from incorrect use of the device.

Warning!

It is likely that the BLACK BT software still contains some errors. We put a lot of effort into finding them and tested the software carefully, but we need to assume that some errors still remain undetected.



Those errors may cause the device to show incorrect data during the dive, reset or even completely shut off during the dive. It must be assumed that BLACK BT as any electronic device will fail sooner or later. Electronic devices cannot replace knowledge and proper training. During the dive **never** rely only on one source of information about current depth, dive time and decompression time and/or no-decompression limits.

Use spare device to measure time and depth and dive tables. Make sure that you can finish the dive safely in case you lose the bottom timer or it will fail during the dive.

5. READ BEFORE USE 2/3



Before you move to further instructions or/and start using BLACK BT bottom timer, **read carefully all warnings and information described below and always follow them.**

- **BLACK BT is not a diving computer** and fails to provide information on no-decompression limit (NDL) and decompression stops. Before you use BLACK BT **always** plan carefully your dive using the appropriate tables and software in order to be in line with the knowledge you have obtained during the training.
- BLACK BT requires basic knowledge of diving which is communicated during the appropriate and properly conducted diving course. This is the reason why BLACK BT cannot be used by individuals who have not completed a full diving training by recognized training agency, except for situations when BLACK BT is used for training purposes under instructor supervision.
- BLACK BT can **never** be the only device measuring depth and time you take under water. Remember that it is strongly required you to have a backup device measuring diving depth and time which can be used in case of main device failure.
- Before the first use, set up carefully and understand all parameters and learn how to use all of the functions and after reading this manual, practice using the bottom timer during shallow dives (up to 10m) in safe conditions.

6. READ BEFORE USE 3/3

- Always consider the fact that BLACK BT like any other electronic device can fail and provide you with incorrect depth, time and ascent rate data, despite the apparently proper operation. In case you notice software malfunction or errors, stop using it for dives and contact the manufacturer immediately.
- Exceeding the maximum ascent rate can cause decompression sickness, resulting in serious injury or death. Never exceed optimal and maximum ascent rate recommended by the diving agency you obtained certificates from, regardless of vertical speed indicator (VSI) displayed on BLACK BT.
- BLACK BT is equipped with o-ring seals, which does not require any maintenance during the entire use process. Battery should be replaced at the service centre authorized by the device manufacturer. Opening the device by untrained individuals can result in device damage or improper operation/malfunction, which results in the loss of guarantee.
- If you observe incorrect operation of your device or any errors in its software, under no circumstance should you use it for diving, instead immediately contact the producer.
- Never use software from any other source than the manufacturer's website providing updates for the device. Such software can include errors leading to improper device operation, which may result in injury or even death.

7. BASIC ELEMENTS

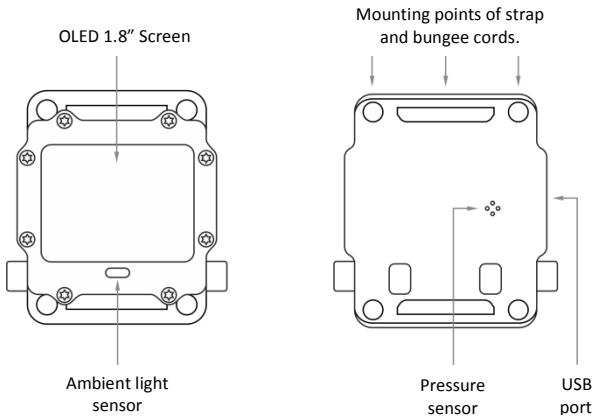

8. STRAP ASSEMBLY

BLACK BT can be fixed on the hand with the supplied strap. In order to fix it, you need to thread the strap through the holes in the case, as shown in figure below:

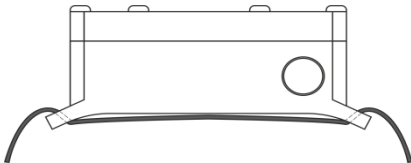

9. BUNGEE CORD MOUNTING

BLACK BT has four holes for bungee cord mounting:

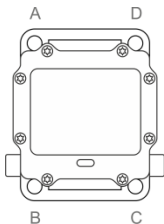

In order to install the bungee cord:

1. Tie a knot at the end of the cord. Next, thread the bungee cord through A hole so that the knot is placed from the display side.
2. Thread the end of the bungee cord through holes B, C and D. The length of the knot between holes A-B and C-D should be adjusted to the hand size.
3. Tie a knot in the appropriate place on the free end of bungee cord. Cut the remaining bungee part and singe it with a lighter.



It is advisable to tie a knot between points B and C as protection against the loss of device, in case the bungee cord should break.

10. INITIAL START UP OF DEVICE

On initial start up of the device, the BLACK BT will display the configurator for setting some basic options (language, date and time, units). After they are set, the device will start its surface mode.



When first started, the battery indicator will always indicate total discharge of the device. This is intentionally set like this during the production process, after the complete charge, for user's safety.

After connecting to the charger, the BLACK BT will indicate subsequent charging stages and when it detects that the battery is fully charged, value 100% will be displayed. It is a standard procedure resulting from safety mechanisms implemented in this device.



Attention! Before the first use and also directly before each dive check the settings of the device!

11. DEVICE START-UP ON THE SURFACE

In order to start up BLACK BT on the surface, simultaneously press both buttons briefly with 1s interval several times.



If the device fails to start, the battery is probably discharged. In such case, connect the charger and then start the device again.

Once done, BLACK BT will start up in surface mode and display the following information:



To save battery energy, BLACK BT turns off after several minutes of non-operation.

12. BUTTONS

BLACK BT has two buttons. Each of these buttons detects both a 'quick press' (under 0.5s) and 'hold' (over 0.5s).

Button functions for the main screen, additional information screen and compass screen:

Quick press



Hold activates the main menu screen

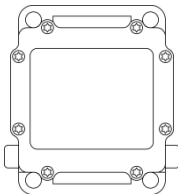

Quick press



Hold activates the context menu screen

In the menu, functions assigned to 'hold' are described on the screen:

Function activated after holding the left button

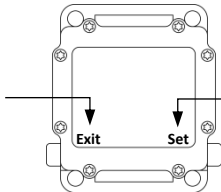

Function activated after holding the right button

13. MENU OPERATIONS

BLACK BT has two types of menus:

- Main menu – activated after holding the left button on any screen;
- Context menu – activated after holding the right button on screens which provide such menu type (e.g. compass).

Menu items include several types of graphical symbols indicating functions performed by them:

- ▶ Item including sub-menu. Hold the right button to enter the sub-menu.
- ◀▶ Item for setting the value. Hold the right button to enter edit mode and then by pressing briefly, set the value.
- ◻ Turn on/off item. Hold the right button to change the state.



By pressing briefly both buttons at the same time you immediately return to the main menu, regardless of the menu level you are in.

14. DIVING – DIVE START

BLACK BT is equipped with water sensor activated automatically once in contact with water; therefore, it does not require to be turned on manually before entering the water. It enters the diving mode at depth of 1.5m.

Water sensor was calibrated to detect both salt and fresh water. However, in particular environments (e.g. mountain lakes) water conductivity is too low for the sensor to detect it. In such situation, the device will activate through pressure sensor at depth of 0.5m.



If the battery charge level totals less than 20%, BT will not enter the diving mode and will display message 'Do Not Dive'. Always check the battery charge level before entering the water.



Even though BT activates automatically, before entering the water always make sure that the device operates correctly.



BLACK BT activates depth and time measuring mode after entering the diving mode. The max. depth for the device to activate measuring is 1.5m.

15. DIVING – MENU FUNCTIONS

There are additional functions which appear in main menu during the dive:

Reset timer

This function resets timer.

Pause timer / Resume timer

This function holds and then starts the timer once selected again.

When the timer is held,  icon is displayed.

Turn off alarm

This function is only available when any alarm is displayed. It mutes the alarm. Attention: this function has no impact on alarms which occur after activating this function.

Reset avg

This function resets the average depth.

16. DIVING – MAIN SCREEN 1/2

Main screen of the device contains all basic information on the current situation of the dive:

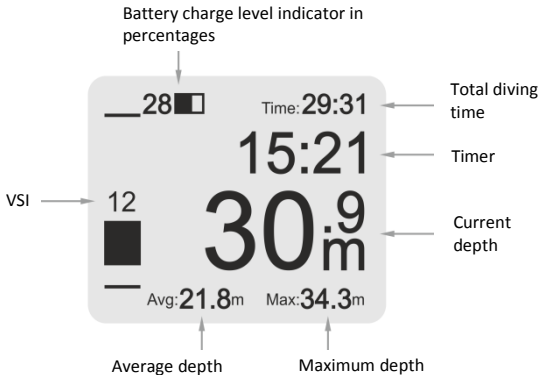

Attention! The Battery charge level indicator specifies only approximate battery charge level. Always charge the battery before diving.

17. DIVING – MAIN SCREEN 2/2

You can select one of the three main screen modes: full, simple or minimum. The layouts differ from one another in terms of the amount of displayed information.

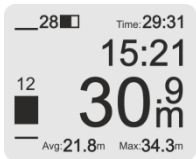

Full

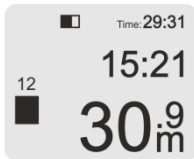

Simple

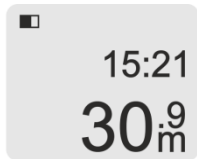



Minimum

To select the display mode of the main screen, enter: **Settings -> Views -> Main menu.**

18. DIVING – VSI

The state-of-the art VSI indicator provides accurate buoyancy control and both ascent and descent speed. It displays not only the current speed rate in meters per minute, but also shows the rate in relation to the set optimal and max. speed. The VSI indicator is displayed on the main screen and compass screen, to their left.

When you maintain neutral buoyancy, the indicator does not deflect to any direction. When you start descending or ascending, the indicator will deflect appropriately down or up. The deflection volume corresponds to the descent or ascent rates.

-  Optimal ascent rate level
-  Graphic indicator of current ascent/descent speed.
- 8** Ascent or descent rate in m/min.

-  Optimal descent rate level.

The indicator colour depends on ascent/descent rate: standard colour corresponding to the range from zero to optimal rate; warning colour corresponding to the rate exceeding the optimal one, and alarm colour corresponding to the rate exceeding the max. one.



Attention! Too fast ascent may cause decompression disease (DCS).
Before diving always check correct speed settings for VSI indicator!

19. DIVING – ‘ADDITIONAL INFORMATION’ SCREEN

‘Additional information’ screen provides information on current time, water temperature and depth diagram (dive profile):

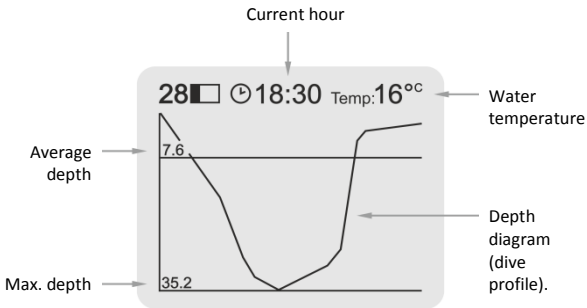

The line colour of dive profile also shows possible excess of optimal and max. rates, according to VSI settings. Therefore, it is easy for you to identify possible irregularities in dive profile (reversed, yo-yo profile, etc.), which may require extending the decompression stops or increasing the surface interval before the next dive.

20. ALARM DISPLAY 1/2



Attention: The default alarm colour in all BLACK BT colour schemes is red. The user can change the alarm colour in the settings.



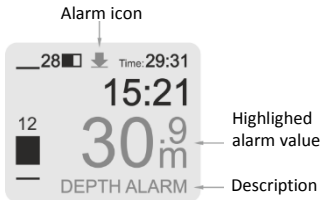

The BLACK BT alarms are indicated in three ways: by highlighting the value causing the alarm, by displaying an alarm icon and its description on the main screen. Moreover, when the alarm occurs, the screen background changes its colour to the alarm one several times and then flashes every 10 seconds until turned off.



Attention! In some situations the device may not display the alarm even if there occur conditions in which the alarm should be displayed, or the device may display a false alarm. Therefore, always react to the appearing alarms but never rely on them in 100%. Assess the situation based on any available information and not based on the alarms.

21. ALARM DISPLAY 2/2

Black BT allows setting the following alarms:

- | | |
|--|--|
|  Dive time | Alarm is activated once a particular dive time is exceeded. |
|  Maximum depth | Alarm is activated once the maximum depth is exceeded. |
|  Average dept | Alarm is activated once the average depth is exceeded. |
|  Battery | Alarm is activated once battery charge indicator drops to a certain level. |
|  Alarm clock | Alarm is activated at a particular hour. |

The alarm can be turned off using 'Turn off alarm' function available in the main menu. The fact that the alarm occurred is saved and indicated in the logbook.

22. COMPASS – SETTING THE BEARING ON THE SURFACE

You may set the bearing before the dive when necessary. In order to set the bearing on the surface, select function „Set bearing” from the main menu, and then direct the bearing line to the object which you want to reach or direct the device on the required course reading its value displayed on the screen. Then save the bearing holding the right button. The bearing saved will be visible on the compass scale as a round point and as a numerical value in the right upper corner of the screen.



After setting the bearing it is necessary to check if it matches the course which you want to follow. If there is a need to correct, the procedure can be repeated and again the device should be directed to the required course pressing the right button.

After setting the required bearing it is necessary to leave the main menu by holding the left button.

23. COMPASS – COMPASS SCREEN IN DIVE MODE

The compass screen presents all information required for navigation and information relating to the current diving situation.

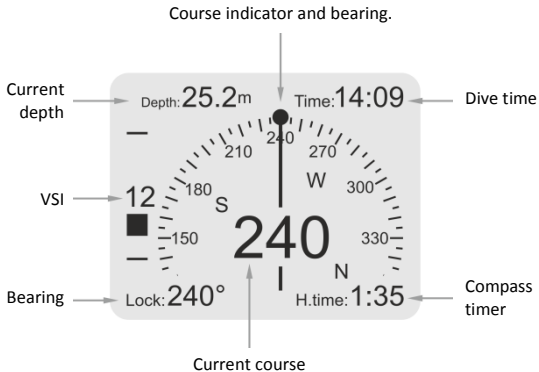

The compass integrated with BLACK TMX operates at deflection +/- 80%. However, you must remember that deflection results in lower accuracy and compass reaction time.

24. COMPASS – CONTEXT MENU

The compass functions are available in the compass context menu. In order to enter it, hold the right button on the compass screen. The compass context menu contains the following functions:

Lock bearing	Sets the course used for navigation.
Reset timer	Resets the compass clock. This function is useful in situations when a compass bearing is set on the surface and navigation starts only after you enter the water.
Pause/resume timer	Holds and starts the compass clock again. This function is useful in situations when it is required to pause navigation for a moment.
Bearing list	Allows selecting the desired bearing from the list.
Next bearing	Activates the next bearing from the list.
Previous bearing	Activates the previous bearing from the list.



Functions 'Course list', 'Next bearing' and 'Previous bearing' are visible only when the course list was determined. More information in chapter: 'Compass – navigation as per the course list'.

25. COMPASS – BEARING NAVIGATION

The digital BLACK BT compass allows you to set the course (bearing lock) and then navigating it.

In order to set the course, set the compass bearing, so that it is placed in the axis between you and the destination you wish to reach. Then select “Lock bearing” in the compass context menu. The set course will be visible on the compass scale as a round point. Upon setting the course, the compass clock will start to measure the time you swim towards a given direction.

In case of course deviation, the compass will alert you by changing the colour of the bearing and the course indicator. In order to help maintain the direction in case of deviation, the compass will indicate the direction you need to take to return to the correct course:



26. COMPASS – ‘RETURN’ FUNCTION

‘Return’ function allows you to turn on navigation quickly in a reverse direction after you swam some distance with a set course. Therefore, you can take a defined course for a while and come back to same place using the opposite course.

The „Return” function is available in compass context menu.

It is possible to activate the ‘return’ function only when you set the course beforehand. Once „Return” option is selected, the compass will automatically set a reverse course (-180° relative to the previous course). Once you take the new course, compass clock will start counting the time back.



The ‘Return’ function operates correctly if during the previous navigation the correct direction was maintained all the time. In case of significant deviations, you will reach a different destination than the one where you started.

27. COMPASS – NAVIGATION BY BEARING LIST 1/2

The BLACK BT is equipped with a diving compass that is the first in the world to provide navigation by a set course list. This feature allows you to navigate easily in the water and visit all attractions successively.

The course list contains the course and time necessary to cover a particular section:

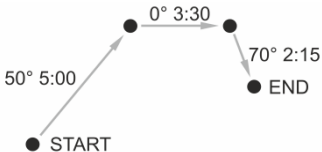

In order to make the course list, connect the device to PC with USB cable and upload „HEADING.TXT” file into „HEADINGS” catalogue. This text file should contain the course value in degrees and time spent on covering the distance in seconds, separated by a semicolon. Each destination must be placed as a separate line. For example the file content should read as follows:

50;300

0;210

70;135

28. COMPASS – NAVIGATION BY BEARING LIST 2/2

Once the file is uploaded correctly into „HEADINGS” catalogue, the first course from the list will be selected automatically after you start the compass. Once you take the correct direction, compass clock will start counting the time down, starting from the value set for the first course.

After counting down the time of the first course, the compass will automatically set a new course and direction indicator will indicate where to turn to find the correct course. In situation when the course is switched before you reached the destination, you can select the current course again using ‘Previous bearing’ function in the compass context menu.

The ‘Course list’ function allows the list to be reviewed and any course can be selected. The current course is marked with icon on the list.

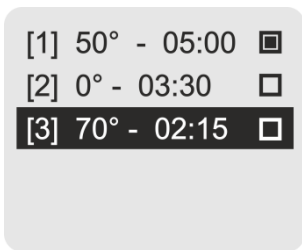

29. LOGBOOK – VIEWING THE DATA

You can review your dive history in 'Logbook' which is stored in the device memory and available in the main menu. The first page shows the list of dives where the consecutive columns indicate: dive no., date, dive no. on a particular day, and the total no. of dives on a particular day.

In order to see the dive details, hold the right button on a given line. This information is grouped on several pages:

- Basic information;
- Log of the relevant dive events;
- Dive profile;
- Temperature diagram.

In order to switch between pages press the buttons briefly. To scroll the events in dive log press the right button.



If during the dive the battery discharges to the alarm level, logbook records are switched off. The logbook data from such dive will be incomplete and some values may look damaged.

30. LOGBOOK – EXPORTING ENTRIES IN UDDF FORMAT

The BLACK BT enables exporting of data to a file in UDDF format compatible with most of the good logbook programs for desktop computers. In order to generate a UDDF file for a particular dive, enter the data in the logbook and then on the first page (basic information) hold the right button starting function "UDDF eksport".

The generated file with dives records will be saved in LOGBOOK catalogue in the device memory. To access the file, connect the device to the PC using USB cable. The BLACK BT should be recognized by the PC as MSD (Mass Storage Device) and you will be able to go through the files stored in the device memory.



If the memory is full, BLACK BT will overwrite records in the logbook starting from the oldest ones. From time to time, archive your dive data on PC.

31. SETTINGS – BASIC PARAMETERS

Settings -> Language	Change of language in which the information is displayed.
Settings-> Units	Selection of unit display method (metric/imperial).
Settings-> Date and hour	The set of functions allowing the date and hour and time display mode (12h/24h) setting.

32. SETTINGS – ALARMS 1/2

Settings -> Alarms -> Dive time

This function allows setting the dive time alarm.

Settings -> Alarms -> Max. depth

This function allows setting the maximum dive depth alarm. The alarm will be activated each time when the current depth exceeds a particular value.

Settings -> Alarms -> Average depth

This function allows setting the average dive depth alarm. The alarm will be activated each time when the current depth exceeds a particular value.

Settings -> Alarms -> Battery

This function allows setting the battery charge level at which the device will activate the alarm. This alarm is active in addition to basic battery alarm which is always displayed when battery charge level drops to 20%.

33. SETTINGS – ALARMS 2/2

Settings -> Alarms -> Alarm clock

This function sets the alarm which is activated at a particular hour in dive mode.



The 'Alarm Clock' is not a classical alarm clock and does not operate in the surface mode. This alarm is displayed only in the underwater mode.

34. SETTINGS – ASCENT RATE FOR VSI

Settings -> VSI ranges

This set of functions allows configuration of optimal and maximum ascent /descent rates in metres per minute or feet per minute for various ranges of depth.

In order to add a new range, select **Settings -> Ascent/Descent -> Add range** and set the depth at which the range begins.

If any ranges were already determined in the device, the new range will contain the already set depth up to the depth of the next range or the maximum depth.

Example: Adding a range from 18m depth will result in displaying two ranges on the screen: 0 - 18m and 18m - max.

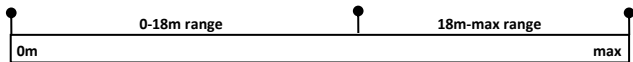

In this situation, adding another range starting from 6m depth will result in displaying three ranges on the screen: 0 - 6m, 6 - 18m, 18m - max.

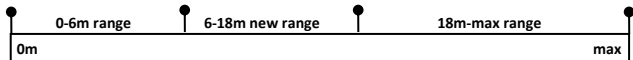

35. SETTINGS – DISPLAY 1/2

Settings -> Display -> Brightness

Screen brightness can be set within a range of 25% - 100%. In „auto“ mode, adjustment is made via light sensor placed in the device case in order to ensure best readability in different lighting conditions.

Settings -> Display -> Colour scheme

Selection of one from among many pre-defined screen colour sets.

Settings -> Display -> My colours

Modification of selected colour set via colour change of particular screen elements.



Upon setting own set of colours make sure that the alarm colour and the warning colours differ significantly from other colours. Otherwise, you may miss the activated alarm!



If after setting own set of colours, any pre-defined set is selected again, the user settings shall be replaced with the selected one.

36. SETTINGS - DISPLAY 2/2

Settings -> Display -> Auto DIM

This function allows turning on the screensaver in underwater mode after a particular time. Screen blanking does not turn off the device, but switches into selected blanking scheme (darkening, screen turn off, change of colour into green, red or blue). In order to restore normal display, the user should press any button.



If the alarm occurs when BLACK BT screen is turned off, the device will automatically switch into normal display so that the user does not miss the alarm. The screen blanking function will remain turned off until the user turns off the alarm by selecting function 'Mute alarm'.

Settings -> Views

Functions allowing turning on/off particular views (main screen, compass), change of sequence and the type of main screen display (full, simple, minimum).

37. SETTINGS – USABILITY PARAMETERS 1/2

Settings -> Usability -> Flip

This function allows turning on and setting sensitivity of automatic screen flip in situation when the user shows BT to his/her partner. With the set level, the angle at which screen flip occurs is changed.

Settings -> Usability -> Menu timeout

This is the interval after which the device automatically exits the menu and enters the main screen. Time is counted down since the button was last pressed.

Settings -> Usability -> View timeout

This is the interval after which the device automatically goes back to the main screen. Time is counted down since the button was last pressed.

Settings -> Usability -> VSI sens.

This is the sensitivity of ascent/descent speed rate indicator.



Function 'Compass lock' allows turning off the automatic return to the main screen for compass mode. Using this function means that the BLACK will not automatically switch from compass back to the main screen.

38. SETTINGS – USABILITY PARAMETERS 2/2

Settings -> Usability -> Button lock

This function allows you to run an automatic key lock after a certain period of time, thereby preventing the change of device parameters by pressing keys accidentally. The keys are locked only in an dive mode. Once the keys are locked, the lock icon is displayed at the top of the screen. If you press any keys, the 'LOCKED' message will be displayed at the bottom of the screen and the device will not react.

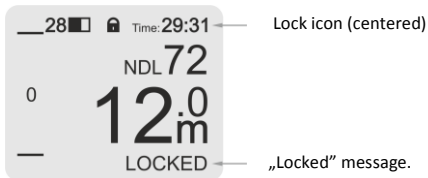

In order to unlock devices, simultaneously press both buttons briefly with 1s interval three times in the same way as when switching the device on. Once the device is unlocked, the lock icon disappears and the 'UNLOCKED!' message is displayed at the bottom of the screen.



Note: Locking the keys makes it impossible to use the device functions until it is unlocked manually (including the gas change function). Once this function is activated, you have to practice unlocking the keys in shallow water.

39. SETTINGS – WATER SALINITY

Like all devices of this type, the BLACK BT measures the descent depth indirectly, recalculating the measured pressure into meters of water column taking into account water density resulting from the salinity. If the device calibrated at a particular salinity value is used in water of different salinity, the displayed depth can be distorted.

Using the function **Settings** -> **Practical** -> **Salinity**, you can set the salinity value which the device will take into account while performing calculations.

The device makes it possible to set one of three predefined values:

- Saltwater – salinity 1030 g/dm³
- EN 13319 (default) – salinity 1020 g/dm³, in line with the European standard EN13319;
- Freshwater – salinity 1000 g/dm³.



The correct reading of the depth may have influence on the performed diving plan. Before the dive make sure that you set the correct value of salinity.



If you use devices of various manufacturers, take into account that they can be calibrated with different salinity values. It will lead to differences in the displayed depth in the same conditions. Check in the manual which salinity value was taken into consideration at calibrating them.

40. SETTINGS – LOGBOOK

Settings -> Logbook -> Depth interval

This is frequency of information log on the current depth in seconds.

Settings -> Logbook -> Temp. interval

This is frequency of information log on the current temperature in seconds.

Settings -> Logbook -> Min. time

This is the time interval in seconds after which the descent is recognized as a dive. If a dive time is shorter than the one set, the information will not be saved in the logbook.

Settings -> Logbook -> Min. depth

This is the minimum depth in metres or feet which should be exceeded in order for the descent to be recognized as a dive. Information on dives not exceeding this depth will not be saved in the logbook.

Settings -> Logbook -> Min. surf. int

This is the surface interval in seconds after which the dive is considered to be a new one, not a continuation of the previous one. If a dive interval is shorter than the one set, information will be saved in the logbook as an ongoing part of the previous dive.

41. SETTINGS – COMPASS 1/2

Settings -> Compass -> Compass lock

This function prevents the automatic switch back to the main screen after interval set in **Settings -> Usability -> Screen timeout**.

Settings -> Compass -> Rotation

This function allows rotation of the compass relative to the case, which makes it more comfortable to keep in the correct position during navigation.

In this position, the compass shows the direction in line with the bearing:

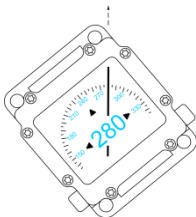

42. SETTINGS - COMPASS 2/2

Settings -> Compass -> Calibration

This function calibrates the compass and whilst the digital compass was calibrated when manufactured,, we recommend you check the accuracy of its readings.

If compass readings are defective, we recommend you calibrate it manually. The compass calibration is always required if the device was exposed to strong magnetic or electric field.

In order to calibrate the compass, find some open space outside of buildings and away from metal objects and electric wires. Then select calibration function in the menu and follow the instructions displayed on the screen. Calibration is performed by setting the wall of the device indicated by the arrow parallel to the ground:

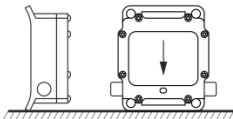
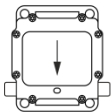
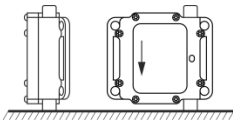
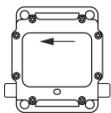

43. SETTINGS – SYSTEM MENU

Settings -> System -> Start demo mode

This function allows activating demo mode presenting underwater features of the device when BLACK BT simulates a dive.

Settings -> System -> Reboot device

This function allows restarting the device. If the device is connected to the PC with USB cable, the restart will result in switching to bootloader mode and software update. In order to exit bootloader mode, the user should disconnect the device from USB.

Settings -> System -> Factory default

This function restores factory settings of all device parameters. Logbook and other device data are not removed.

Settings -> System -> Wipeout device

This function restores factory settings and removes all data from the logbook.



Attention: removal of data from logbook is irreversible!

44. BATTERY CHARGING

The BLACK BT is equipped with a high quality lithium-ion battery which has no memory effect. The manufacturer ensures battery durability up to 1000 life cycles, however the life cycle is very dependent on the operating conditions.

The BLACK BT is charged with the supplied charger or USB cable connected to the PC. In order to charge the device, connect the charger plug as it is shown below:

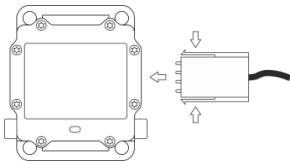

In order to maximize the battery life, follow these rules:

- Try to keep the device battery as fully charged as possible. Charge it as often as possible.
- Do not discharge the battery to the minimum level. Full discharge of the battery can cause irreversible damage.



To charge the device, use only the original charger. Using other charge may damage the device or even cause the battery explosion. **Never leave the product connected to the charger without supervision!**

45. USB CONNECTION

BLACK BT is equipped with a special four-contact USB port situated on the right side of the device. In order to connect the device to PC with USB port, use the charger plug and USB cable supplied with the device.

After correct connection of USB port, enable the USB BLACK BT port by function 'Enable USB' in the main menu. The BLACK BT should be displayed in the system as 'Mass Storage Device'. After the files are copied, disconnect USB cable and the BLACK BT will automatically turn off USB port.



Function 'Enable USB' is displayed only after correct connection of the BLACK TMX to PC or other device equipped with standard USB port.



Some desktop computers may fail to follow the compulsory electromagnetic emission standards and, therefore, may disturb the operation of devices connected to them, leading to their hang-up. To avoid potential problems, always connect first the adapter to BLACK TMX port and then connect it with USB cable.

46. SOFTWARE UPDATE

The BLACK BT can be easily updated with latest software releases using the USB connection. To update the software:

1. Register the device on <http://support.xdeep.eu> and download the current firmware file that is unique for your device.
2. Connect the BLACK BT to USB port in accordance with instructions from the previous page and copy the received file to the device memory in 'firmware' catalogue.
3. Disconnect the device from USB port.
4. Turn on the BLACK BT and select from the menu **Settings -> System -> Restart**

The device should automatically detect new software and start bootloader mode. By pressing the right button you will start the new software. You can check the number of the current software version installed in the device in **Settings-> System -> Information**. If the device states the previous software version, check whether you copied the correct file.



The update file is uniquely generated for each individual BLACK TMX device and cannot be used on any other device. Therefore, if you have two devices, you will have to download software for each of them individually.

47. MAINTENANCE, STORAGE AND SERVICE

BLACK BT does not contain any elements which can be serviced by the user. In case of any irregularities in the device operation, the device shall be withdrawn from use and the user should contact the producer.

Time period recommended for assessing the accuracy of the readings totals one year or 100 dives.

To ensure long and failure-free operation of the device, respect the following rules:

- After each use rinse the device carefully in clean fresh water.
- To remove dirt, do not use detergents or solvents since they may irreversibly damage the gaskets or the surface of the device.
- Store the device away from sources of heat, vibrations and strong magnetic fields which may irreversibly damage the components of the device.
- BLACK BT should be store with max. charged battery. During storage, at least every two months the device should be connected to the charger to fully charge the battery.
- Never leave the device exposed to sunlight.

48. LICENCE AND LIABILITIES AGREEMENT 1/5

Software is an integral part of the BLACK BT device. The use of the BLACK BT device for diving is equivalent to the user accepting the conditions of this license:

THIS LICENCE (REFERRED TO IN THIS AGREEMENT AS "AGREEMENT") IS AN AGREEMENT BETWEEN LICENSEE AND XDEEP SPÓŁKA Z OGRANICZONĄ ODPOWIEDZIALNOŚCIĄ SPÓŁKA KOMANDYTOWA - LICENSOR (REFERRED TO IN THIS AGREEMENT AS "XDEEP").

USE OF THE BLACK BT (REFERRED TO IN THIS AGREEMENT AS THE "BLACK BT") IS SUBJECT TO THE TERMS AND CONDITIONS SET OUT IN THIS AGREEMENT AND IN ATTACHED USER MANUAL. THIS AGREEMENT ALSO SETS OUT EXCLUSIONS AND LIMITATIONS OF XDEEP'S LIABILITY TO LICENSEE, PROVISIONS GOVERNING THE RESOLUTION OF DISPUTES BETWEEN LICENSEE AND XDEEP, AND OTHER IMPORTANT PROVISIONS. IF LICENSEE USES THE BLACK BT, LICENSEE IS DEEMED TO HAVE AGREED TO THIS AGREEMENT. THIS AGREEMENT INCLUDES USER MANUAL CONSTITUTING ITS INTEGRAL PART. LICENSEE IS OBLIGED TO READ THE ENTIRE BLACK BT USER MANUAL BEFORE USING BLACK BT. IF LICENSEE USES IT CONTRARY TO THE MANUAL, THEN THIS AGREEMENT EXPIRES WITHOUT A NOTICE.

1. SUBJECT OF THE AGREEMENT

THE SUBJECT OF THIS AGREEMENT IS TO DETERMINE THE RULES ACCORDING TO WHICH THE LICENSOR GRANTS THE LICENSE TO THE LICENSEE TO USE BLACK BT SOFTWARE AND ESTABLISH EXCLUSIONS AND LIMITATIONS OF LIABILITY OF XDEEP.

UNDER THE TERMS OF THIS AGREEMENT, XDEEP UNDERTAKES TO GRANT THE LICENSE TO THE LICENSEE TO USE THE BLACK BT SOFTWARE, IN THE FIELDS OF EXPLOITATION AS REFERRED TO POINT 2 OF THIS AGREEMENT.

49. LICENCE AND LIABILITIES AGREEMENT 2/5

XDEEP DECLARES THAT IT HAS ALL THE COPYRIGHTS TO BLACK BT SOFTWARE AND TO DISPOSE OF IT IN A MANNER CONSISTENT WITH THE PURPOSE OF THIS AGREEMENT, INCLUDING THE RIGHT TO GRANT LICENSES FOR THE USE OF THE BLACK BT DECOMPRESSION SOFTWARE.

THE PARTIES DECLARE THAT BLACK BT PURCHASE PRICE CONTAINS REMUNERATION FOR LICENSE WHICH IS THE SUBJECT OF THIS AGREEMENT.

2 FIELD OF OPERATION

XDEEP GRANTS THE LICENSEE THE LICENSE TO USE THE BLACK BT SOFTWARE IN THE FOLLOWING FIELDS OF EXPLOITATION:

- A. USING BLACK BT DECOMPRESSION SOFTWARE IN THE DEVICE BLACK BT.

THE PARTIES AGREE THAT GRATING THE LICENSE TAKES PLACE ON THE DAY OF FIRST USE OF BLACK BT.

3. LICENSEE'S RISKS AND RESPONSIBILITIES

SCUBA DIVING, FREE DIVING AND ANY OTHER FORM OF UNDERWATER DIVING (REFERRED TO IN THIS AGREEMENT AS "DIVING") ARE INHERENTLY DANGEROUS AND RISKY ACTIVITIES. EVEN WITH THE BEST TRAINING, PLANNING AND EQUIPMENT, PARTICIPANTS MAY BE INJURED OR MAY DIE. LICENSEE ACCEPTS THE RISK OF INJURY OR DEATH AND THE RESPONSIBILITY TO TAKE ALL NECESSARY STEPS TO REDUCE THESE RISKS. IF LICENSEE CHOOSES TO USE BLACK BT, IS OBLIGED TO USE BLACK BT IN ACCORDANCE WITH THE ATTACHED USER MANUAL.

WITHOUT LIMITING THE FOREGOING, IT IS LICENSEE SOLE RESPONSIBILITY TO ACT IN ACCORDANCE WITH ALL PRECAUTIONS SET OUT IN USER MANUAL ENCLOSED TO THIS AGREEMENT.

50. LICENCE AND LIABILITIES AGREEMENT 3/5

4. AGREEMENT LIMITATIONS AND EXCLUSIONS

THE AGREEMENT APPLIES ONLY IF BLACK BT IS USED IN ACCORDANCE WITH THE USER MANUAL. THIS AGREEMENT EXPIRES AND LICENSEE LOSES ITS RIGHT TO USE BLACK BT SOFTWARE IN CASE OF: (I) ANY USE OF THE BLACK BT NOT IN ACCORDANCE WITH THE BLACK BT USER MANUAL; (II) USE OF THE BLACK BT WITH OR CONNECTION OF THE BLACK BT TO ANY PRODUCT, ACCESSORY, SOFTWARE AND/OR SERVICE NOT MANUFACTURED, SUPPLIED OR APPROVED BY XDEEP

5. NO OTHER REPRESENTATIONS, WARRANTIES OR GUARANTEES

TO THE MAXIMUM EXTENT PERMITTED BY LAW, THE WARRANTIES PROVIDED UNDER GUARANTEE CERTIFICATE ENCLOSED TO THIS AGREEMENT ARE LICENSEE SOLE AND EXCLUSIVE RIGHTS, AND XDEEP'S SOLE AND EXCLUSIVE LIABILITIES AND OBLIGATIONS TO LICENSEE, IN CONNECTION WITH LICENSEE'S PURCHASE AND USE OF THE BLACK BT, AND ARE IN LIEU OF EVERY AND ALL OTHER REPRESENTATIONS, WARRANTIES AND GUARANTEES OF ANY NATURE OR KIND WHATSOEVER.

6. EXCLUSION OF DAMAGES

NOTWITHSTANDING ANY OTHER PROVISION OF THIS AGREEMENT, AND EXCEPT FOR XDEEP'S WARRANTY OBLIGATIONS UNDER GUARANTEE CERTIFICATE ENCLOSED TO THIS AGREEMENT, IN NO EVENT WILL XDEEP BE LIABLE TO LICENSEE OR ANY OTHER PERSON FOR ANY DIRECT, INDIRECT, INCIDENTAL, PUNITIVE OR EXEMPLARY LOSS OR DAMAGE ARISING FROM, CONNECTED WITH, OR RELATING TO THE BLACK BT, OR USE OF BLACK BT, THIS AGREEMENT, THE SUBJECT MATTER OF THIS AGREEMENT, OR OTHERWISE, INCLUDING LOSS OF DATA, SAVINGS, INCOME OR PROFITS.

51. LICENCE AND LIABILITIES AGREEMENT 4/5

7. PERSONAL INJURY OR DEATH

LICENSEE HEREBY AGREES THAT HE UNDERSTANDS AND ACCEPTS ALL RISKS ASSOCIATED WITH DIVING AND USE OF BLACK BT IN ACCORDANCE WITH USER MANUAL ENCLOSED TO THIS AGREEMENT, AND THAT XDEEP IS NOT LIABLE TO LICENSEE OR ANY OTHER PERSON FOR ANY LOSS, DAMAGE, COST, EXPENSE OR CLAIM ARISING OUT OF, CAUSED BY OR RELATING TO LICENSEE PERSONAL INJURY OR DEATH WHILE DIVING, EVEN IF LICENSEE PERSONAL INJURY OR DEATH IS CAUSED, IN WHOLE OR IN PART AND DIRECTLY OR INDIRECTLY, BY THE BLACK BT OR LICENSEE USE OF THE BLACK BT, AND REGARDLESS OF WHETHER OR NOT THE BLACK BT FUNCTIONED PROPERLY OR WAS DEFECTIVE IN ANY WAY.

LICENSEE HEREBY IRREVOCABLY WAIVES AND RELEASES XDEEP FROM ANY LIABILITY OR OBLIGATION TO LICENSEE FOR ANY LOSS, DAMAGE, COST, EXPENSE OR CLAIM ARISING OUT OF, CAUSED BY OR RELATING TO LICENSEE PERSONAL INJURY OR DEATH WHILE DIVING, EVEN IF LICENSEE PERSONAL INJURY OR DEATH IS CAUSED, IN WHOLE OR IN PART AND DIRECTLY OR INDIRECTLY, BY THE BLACK BT OR LICENSEE USE OF THE BLACK BT, AND REGARDLESS OF WHETHER OR NOT THE BLACK BT FUNCTIONED PROPERLY OR WAS DEFECTIVE IN ANY WAY.

8. LIMITATION OF LIABILITY

IF NOTWITHSTANDING THE PROVISIONS OF SECTIONS 5, 6 AND 7 OF THIS AGREEMENT XDEEP HAS ANY LIABILITY OR OBLIGATION TO LICENSEE, XDEEP'S TOTAL CUMULATIVE LIABILITY, INCLUDING DAMAGES AND COMPENSATIONS, TO LICENSEE OR TO ANY OTHER PERSON ARISING FROM, CONNECTED WITH, OR RELATING TO THIS AGREEMENT, THE BLACK BT, ANY OTHER SOFTWARE OR LICENSEE USE OF THE BLACK BT, ANY OTHER SOFTWARE, OR OTHERWISE, FROM ANY AND ALL CAUSE OR CAUSES WILL NOT EXCEED THE PURCHASE PRICE OF THE BLACK BT, AND LICENSEE HEREBY RELEASES XDEEP FROM ANY AND ALL OBLIGATIONS, LIABILITIES, CLAIMS OR DEMANDS IN EXCESS OF INDICATED LIMITATION.

52. LICENCE AND LIABILITIES AGREEMENT 5/5

9. APPLICATION OF EXCLUSIONS AND LIMITATIONS

SECTIONS 6, 7 AND 8 SHALL APPLY TO ALL LOSSES, DAMAGES, COSTS, EXPENSES, CLAIMS, LIABILITIES AND OBLIGATIONS, UNDER ANY THEORY OF LIABILITY, REGARDLESS OF ANY NEGLIGENCE AND GROSS NEGLIGENCE OR OTHER FAULT OR WRONGDOING BY XDEEP OR ANY PERSON FOR WHOM XDEEP IS RESPONSIBLE.

10. GOVERNING LAW AND JURISDICTION

THIS AGREEMENT AND ALL RELATED MATTERS WILL BE GOVERNED IN ACCORDANCE WITH POLISH LAW, EXCLUDING THE UNITED NATIONS CONVENTION FOR THE INTERNATIONAL SALE OF GOODS AND ANY RULES OF PRIVATE INTERNATIONAL LAW WHICH WOULD LEAD TO THE APPLICATION OF ANY OTHER LAWS. ANY DISPUTE ARISING FROM, CONNECTED WITH, OR RELATING TO THIS AGREEMENT OR ANY RELATED MATTERS WILL BE RESOLVED BY THE COURT HAVING THE JURISDICTION OVER THE REGISTERED OFFICE OF THE XDEEP AND LICENSEE HEREBY IRREVOCABLY SUBMIT TO THE ORIGINAL AND EXCLUSIVE JURISDICTION OF THOSE COURTS IN RESPECT OF ANY AND ALL SUCH MATTERS.

11. EXCEPTION TO EXCLUSIONS AND LIMITATIONS

THE EXCLUSION OF CERTAIN WARRANTIES AND THE EXCLUSION OR LIMITATION OF CERTAIN LIABILITIES IS PROHIBITED BY LEGISLATION IN SOME JURISDICTIONS. SUCH LEGISLATIVE LIMITATIONS MAY APPLY TO LICENSEE AND TO THIS AGREEMENT.

53. TERMS OF GUARANTEE

These terms of guarantee concern the BLACK BT bottom timer hereinafter referred to as „the Product“. The guarantee covers physical defects which occur only due to reasons within the Product and resulting only from latent material or performance defects, as long as they are detected within twelve months of the date of sale, however not longer than eighteen months since the production date in case of Product defects. In case of finding defects during the time period covered by the guarantee, within 14 days, and at their own discretion, the manufacturer shall repair or replace the Product with a defect-free one or shall return money to the buyer subject to the following exceptions. If the Product defect requires more thorough analysis or testing, the time of repair may be prolonged.

The manufacturer does not guarantee that the Product will operate without interference, errors and failures and that the device will be compatible with any software or device supplied by third parties.

The guarantee does not cover:

- Damage and defects of the Product resulting from the use of the device not in line with the user manual for installation, transport, storage or maintenance;
- Damage and defects of parts and elements of the Product which are subject to natural wear and tear, including displays;
- Batteries;
- Damage and defects of the Product that underwent some repairs, redesign or reconstruction performed by the buyer or any third party;
- Products where serial number and/or guarantee stickers have been removed, altered, damaged or remains illegible;
- Display burnouts which are a result of natural wear and tear;
- Software errors.

The guarantee for the Product does not cover compensation for damage, lost benefits, inconvenience which occur as a result of identifying defects of the Product, and related to filing a complaint about inconvenience or costs. The supply and acceptance of the Product at authorized service point shall rest upon the owner. In order to execute the rights on guarantee it is indispensable to show valid document confirming the purchase of the Product.

54. TECHNICAL SPECIFICATION 1/2

Hardware features

Processor	Energy Micro EFM32 Giant Gecko
Flash memory	8MB
Screen	OLED 1.8" full colour
Compass	Digital, tri-axial
Built-in sensors	Ambient lighting, temperature, salinity, accelerometer
Communication port	USB 2.0 (12Mbit/s)
Buttons	Balanced buttons with an electronic pressure sensor
Dimensions	51 x 66 x 32 mm

Power

Battery	Li-Ion 1190mAh
Power supply	5V
Charge time/battery operation time	1.5h / 15-40h
	Operation time depends on settings and temperature

Operation features

Maximum operation depth	200m
Depth to start measuring	1.5m
Accuracy of depth measure	Min. 1%, typically 0.2%
Max. altitude	3000m
	The device automatically compensates for depth readings relative to atmospheric pressure.
Temperature range	-10°C +50°C

55. TECHNICAL SPECIFICATION 2/2



The BLACK TMX is equipped with a full colour organic led display which guarantees outstanding brightness and contrast, unobtainable by displays made in other technologies. The natural feature of OLED displays is a gradual decrease in brightness/colour change in places where text and graphics are often displayed. In the BLACK TMX we used the world's top quality display, however as happens with all OLED displays, in time it may show the symptoms of natural wear and tear. The OLED display used in the BLACK TMX has a nominal durability of over 12.000 hours. After that time, the brightness may drop by 50%. The decrease in brightness (of one or all colours) is a natural process in OLED displays and is not a manufacturing defect.

XDEEP
EUROPEAN MADE